



Using the ToxiRAE Plus PID

V1.30



- ToxiRAE Plus PID features
- Turning on the ToxiRAE Plus PID
- Recommended Daily Start-up Procedure
- User displays
- Alarm Modes
- Programming displays
- Calibration

- World's smallest PID!
- 6.4 oz with battery (180g)
- 6.0"L x 1.75"W x 1.0"H (15.2 x 4.4 x 2.5 cm)
- 10.6eV lamp standard
- 9.8eV and 11.7eV optional





- 10 hours continuous operation
- Rechargeable, 2.4 V, 1100 mAh, NiCad battery pack or 2AA alkaline battery adapter
- 90 dB buzzer and flashing red LED alarms
- 1 operation key and 2 programming keys
- 8 digit LCD with LED back light
- Optional 4000 points downloadable to PC and stored in non-volatile memory
- Rugged rubber boot with belt clip



- Range:
 - 0 to 99.0 with 0.1 ppm resolution
 - 100 to 2000 ppm with 1 ppm resolution
- Accuracy
 - +/- 2 ppm or +/- 10% of reading when calibrated to 100 Isobutylene
- Response Time
 - < 20 seconds to reach 90% point when exposed to 100 ppm Isobutylene

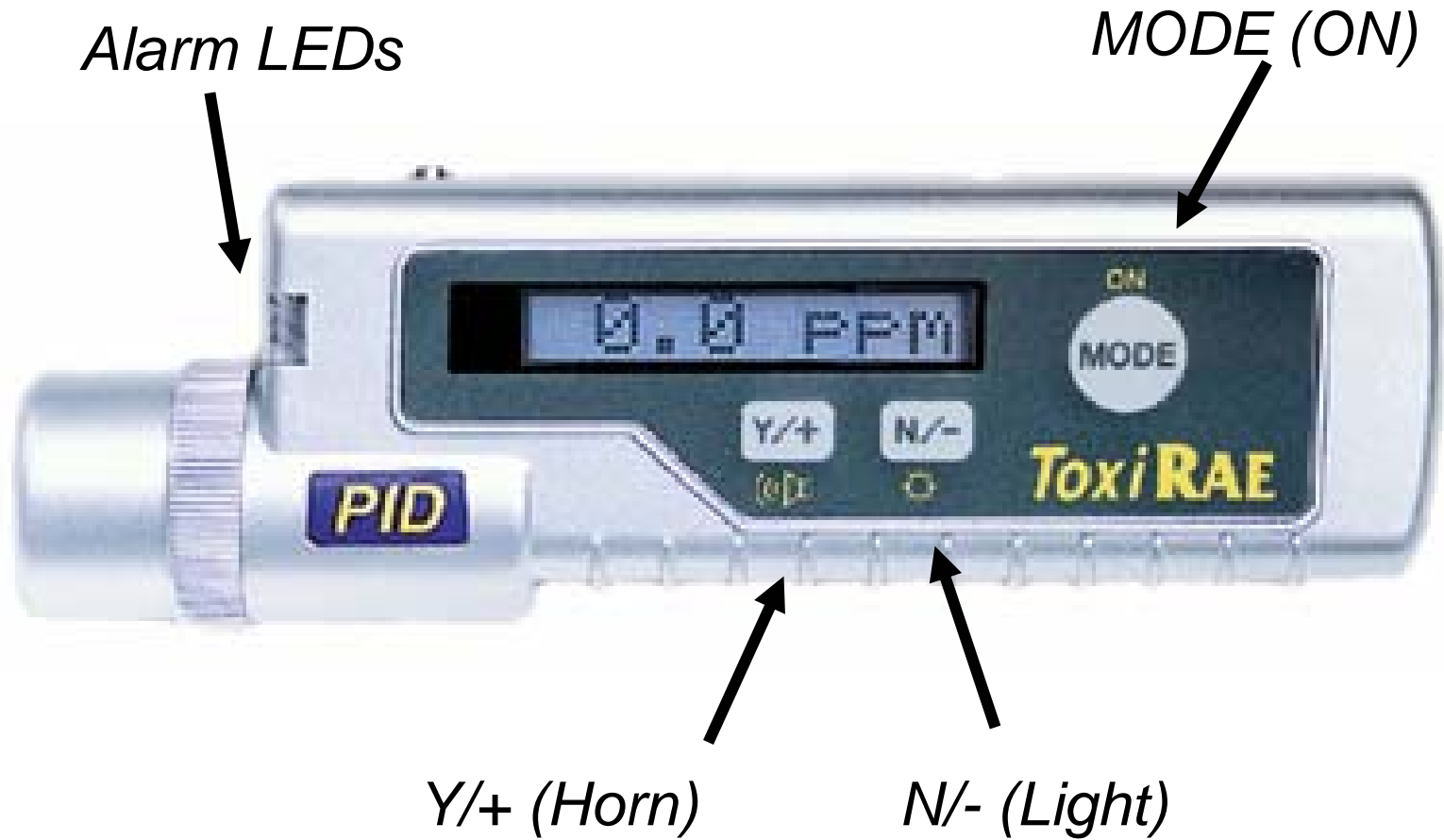



ToxiRAE Plus PID: Physical Description

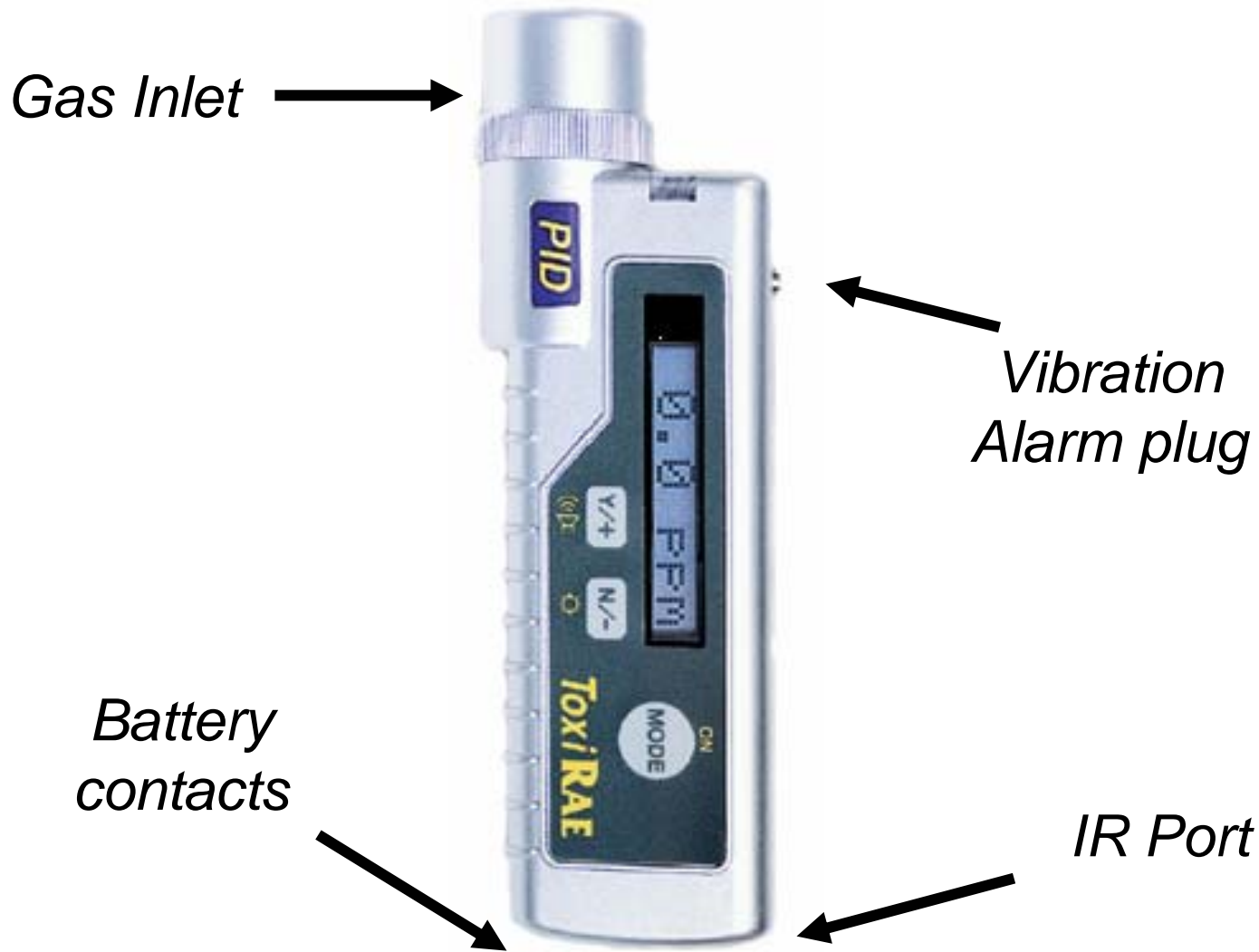



- ToxiRAE Plus PID features
- **Turning on the ToxiRAE Plus PID**
- Recommended Daily Start-up Procedure
- User displays
- Alarm Modes
- Programming displays
- Calibration



- Remove unit from Charging Station
- Hold “MODE” Key to turn on
- Alarm will beep once
- Firmware version will appear, “Ver n.nn”
 - If a “D” follows the firmware version, then the unit is a datalogging unit
- Serial number of unit will follow



- The unit will run through a self-diagnostic routine
 - “Diagnose” appears on the LCD with backlight
 - LED will flash once and buzzer will beep once as part of test
- Warm-up will take approximately 20 seconds
- Watch unit for current settings
 - Preset alarm limits
 - Battery voltage
 - Available data storage memory (in percentage)
- Unit is ready when the display shows instantaneous readings of gas



- ToxiRAE Plus PID features
- Turning on the ToxiRAE Plus PID
- **Recommended Daily Start-up Procedure**
- User displays
- Alarm Modes
- Programming displays
- Calibration



ToxiRAE Plus PID Start-Up: Check PID Zero

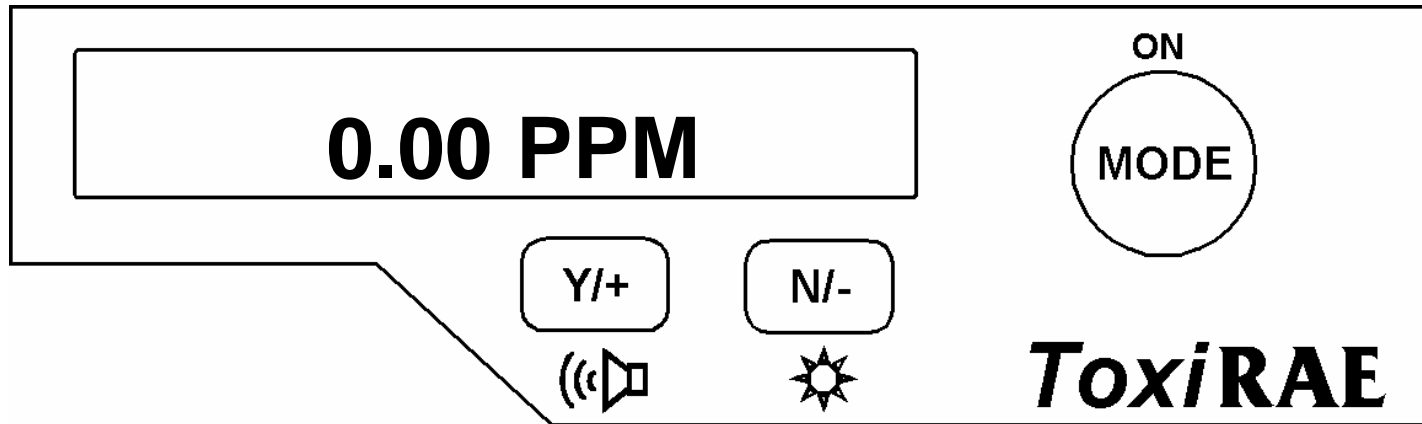

- After 20 sec. warm-up, the ToxiRAE Plus PID should display PID reading
- If there is no alarm, and the PID reading is in the range shown above, then the ToxiRAE Plus PID is ready for use.



ToxiRAE Plus PID Start-Up: Check PID Zero

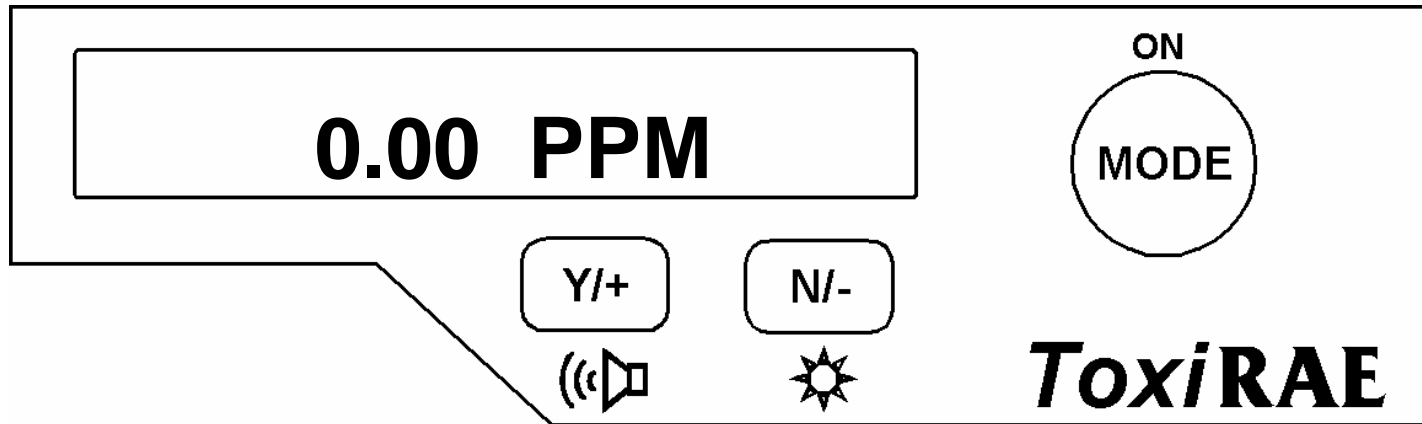

- If reading is outside this limit, wait a few minutes then check again.
 - If reading is in limits use the unit
 - If reading is still outside these limits perform “Zero calibration”

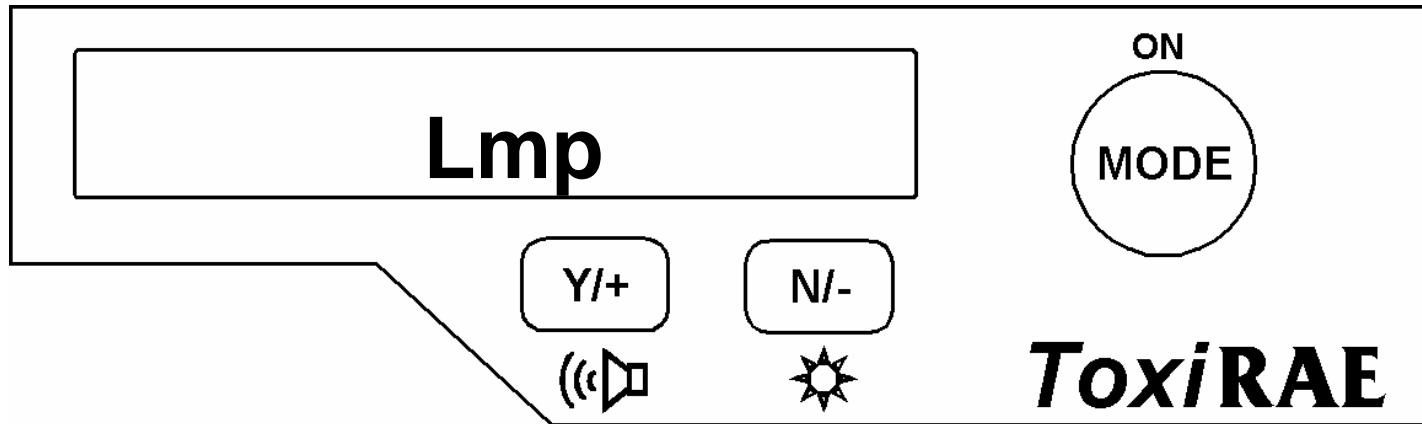

- “Lmp” display along with audible alarm indicates that PID lamp has failed to light
- If after a few minutes the “Lmp” message remains, turn off ToxiRAE Plus PID and restart
 - If after restart “Lmp” message disappears, ToxiRAE Plus PID is ready for use
 - If after restart “Lmp” message remains, the PID needs service

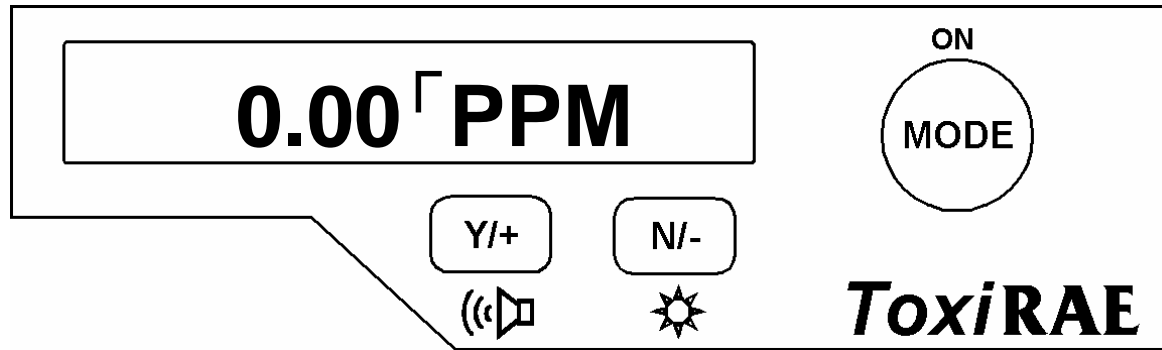

- “ Γ ” indicates that the datalogging is running
- Under the following conditions the datalogging will pause
 - Entering programming mode
 - When communicating with the PC – datalogging will resume when you exit PC communications only if the ToxiRAE Plus PID is in Automatic Datalogging Mode



- Datalogging Modes can only be changed through ProRAE Suite
- ToxiRAE Plus PID has 4 datalogging Modes:
- Manual: datalogging must be turned on manually at the Log On/Off screen
- Automatic: datalogging automatically starts when the unit turns on
- Scheduled Start/Stop: datalogging starts at a specific date and time and will continue to datalog until the stop time and date is reached. The unit must already be turned on
- Periodic Start/Stop: datalogging will start and stop at the same time every day as long as the unit is turned on



- ToxiRAE Plus PID features
- Turning on the ToxiRAE Plus PID
- Recommended Daily Start-up Procedure
- **User displays**
- Alarm Modes
- Programming displays
- Calibration



ToxiRAE Plus PID: User Displays

These eight displays are arranged in a “round robin” order, advance to next screen with MODE key

- Instantaneous readings
- TWA
- STEL
- Peak
- Battery voltage
- Run time
- Log On/Off
- PC Comm?

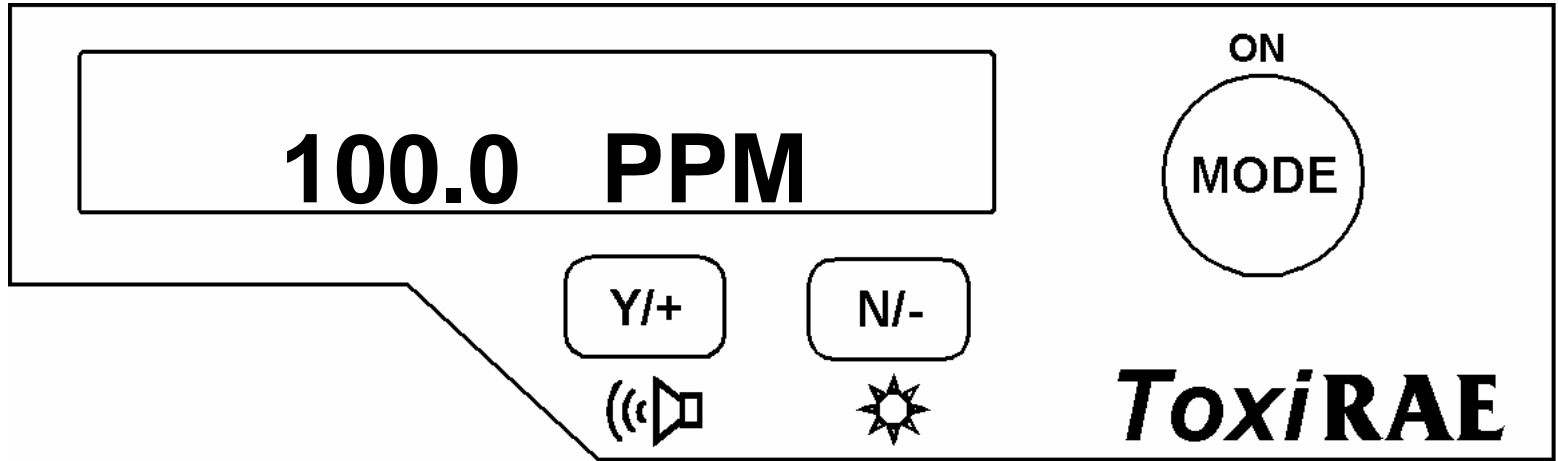

- Main Display
- *Press MODE to move to next screen*

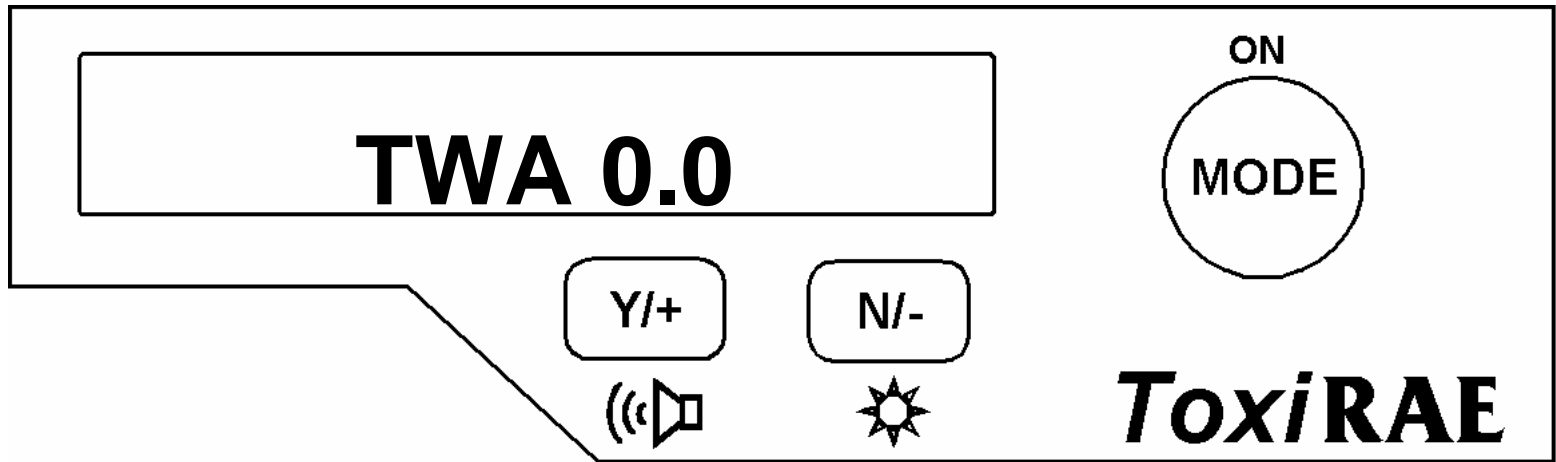

- Time Weighted Average is the accumulated reading of gas concentration divided by 8 hours since the ToxiRAE Plus PID was turned on
- TWA alarm beeps once per second
- *Press MODE to move to next screen*

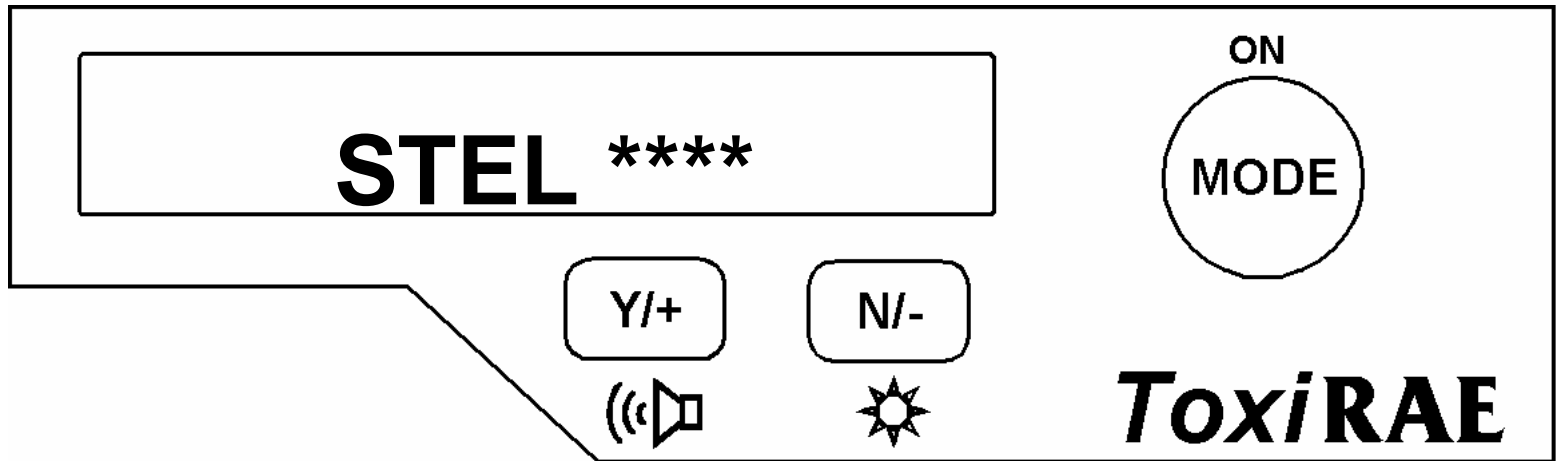

- Short Term Exposure Limit is the accumulated average of the previous 15 minutes
- Displays "****" until ToxiRAE Plus PID has been on for 15 minutes
- STEL alarm beeps once per second
- *Press MODE to move to next screen*

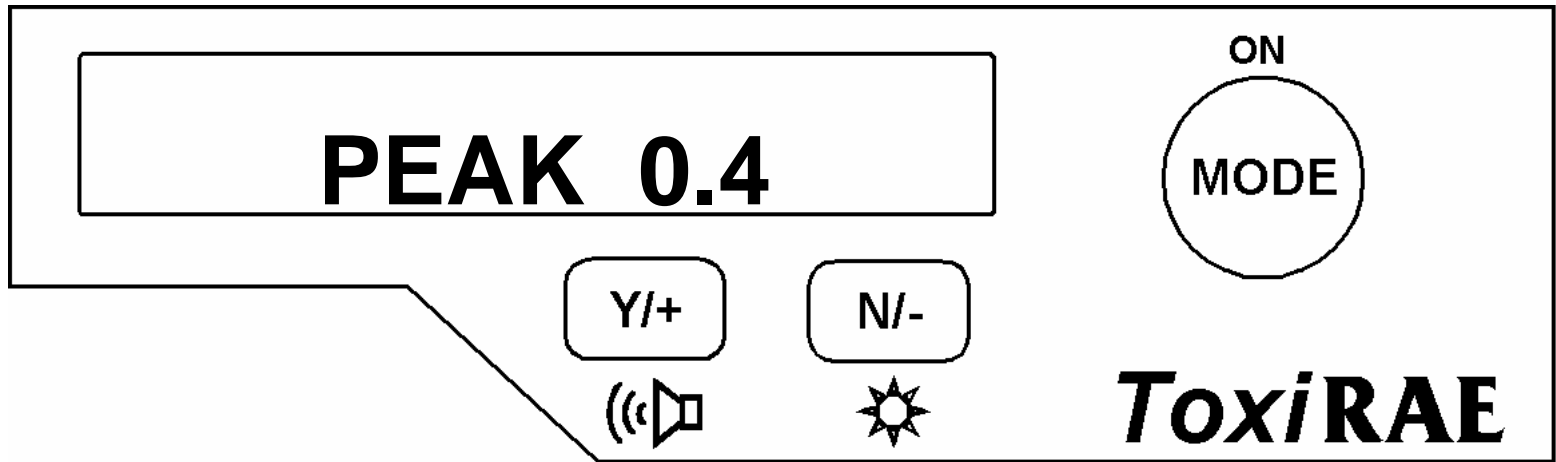

- Holds the Highest reading since ToxiRAE Plus PID was turned on
- *Press MODE to move to next screen*

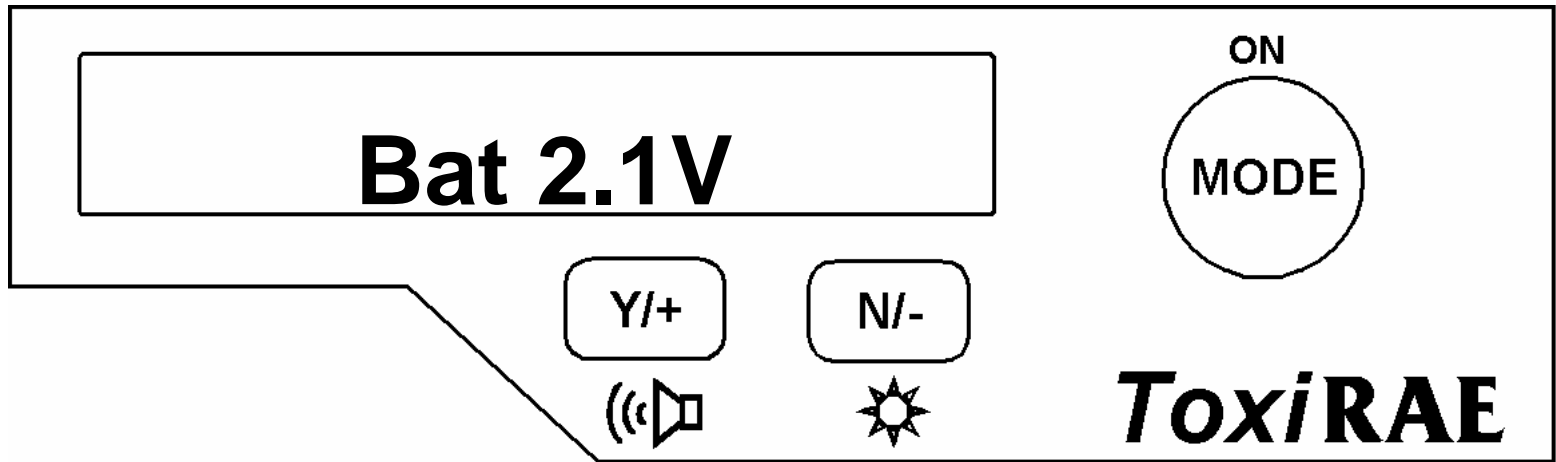

- The current battery voltage reading displayed in volts, reading is updated once per second
- A fully charged battery is 2.8 volts, shut down is at 2.0 volts
- *Press MODE to move to next screen*

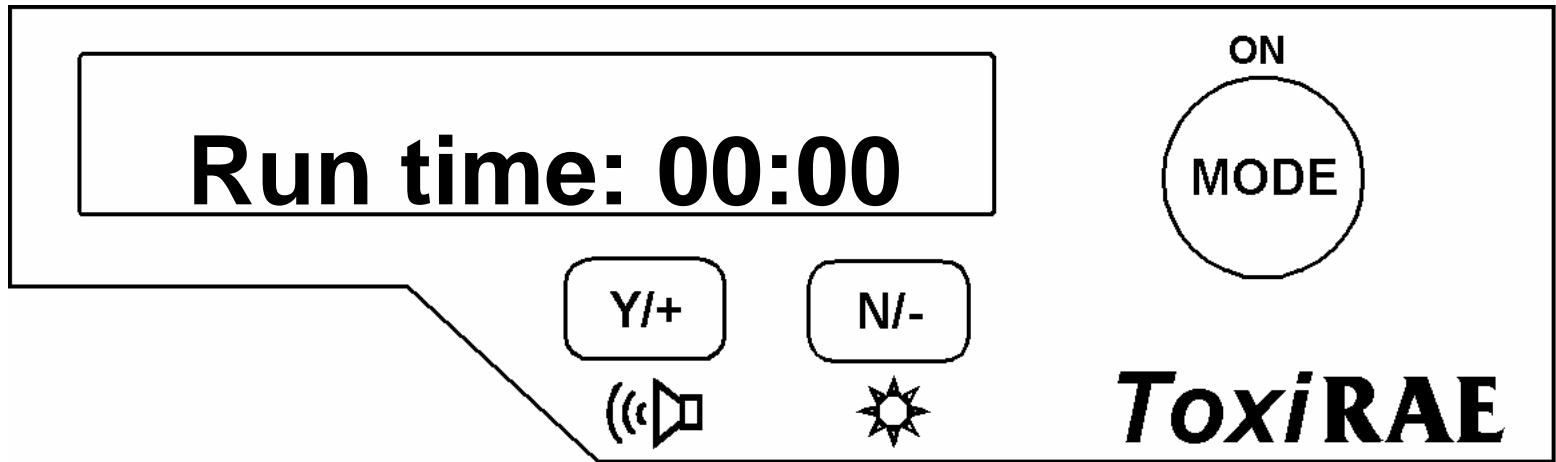

- Accumulated amount of time the unit has been turned on
- Reading is updated at one minute intervals
- *Press MODE to move to next screen*

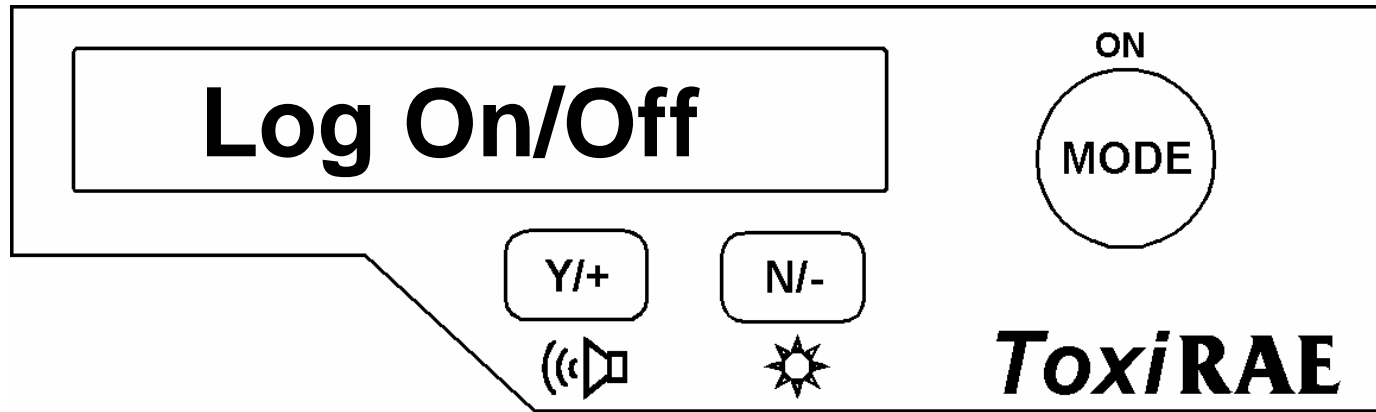

- Starts datalogging if “Y/+” key is pushed now (*Manual datalogging only*)
- If the unit has been datalogging, turns datalogging off
- *Press MODE to move to next screen*



ToxiRAE Plus PID: PC Comm?

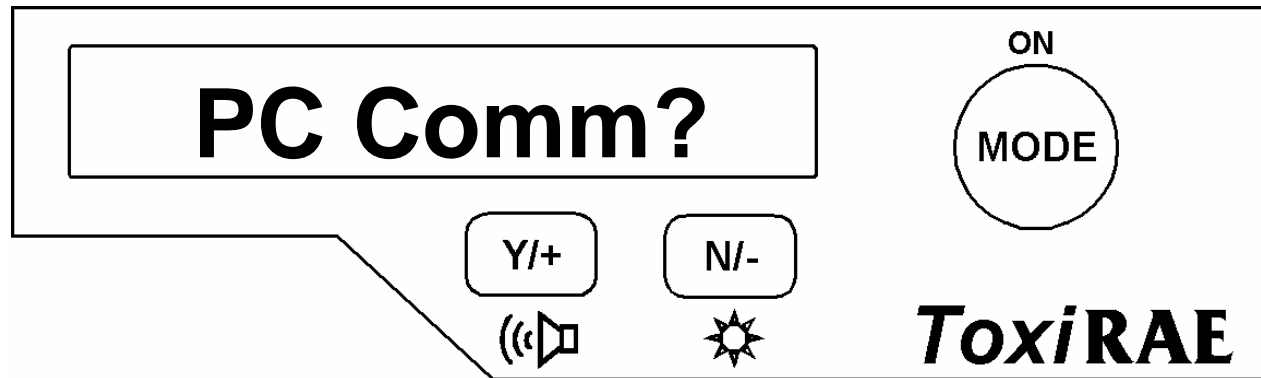

- Press the Y/+ key to place the ToxiRAE Plus PID into communication standby mode
- LCD will display “Ready”
- Place ToxiRAE Plus PID in Charging Station
- Use ProRAE Suite to communicate with unit
 - Note: be sure to have computer prepared, charging station plugged in, and ProRAE Suite up and running as unit will only be able to communicate for a short period of time. The LCD will continue to have “Ready” on the screen, but you will receive an error message when you try to communicate with the PC



- ToxiRAE Plus PID features
- Turning on the ToxiRAE Plus PID
- Recommended Daily Start-up Procedure
- User displays
- **Alarm Modes**
- Programming displays
- Calibration



- **THE ALARM SIGNALS ARE DISABLED DURING PC COMMUNICATION OR CALIBRATION OPERATION.**
- **TO REDUCE THE RISK OF EXPOSURE TO HAZARDOUS ATMOSPHERES, PERFORM PC COMMUNICATION OR CALIBRATION ONLY IN AREA KNOWN TO BE NON HAZARDOUS.**

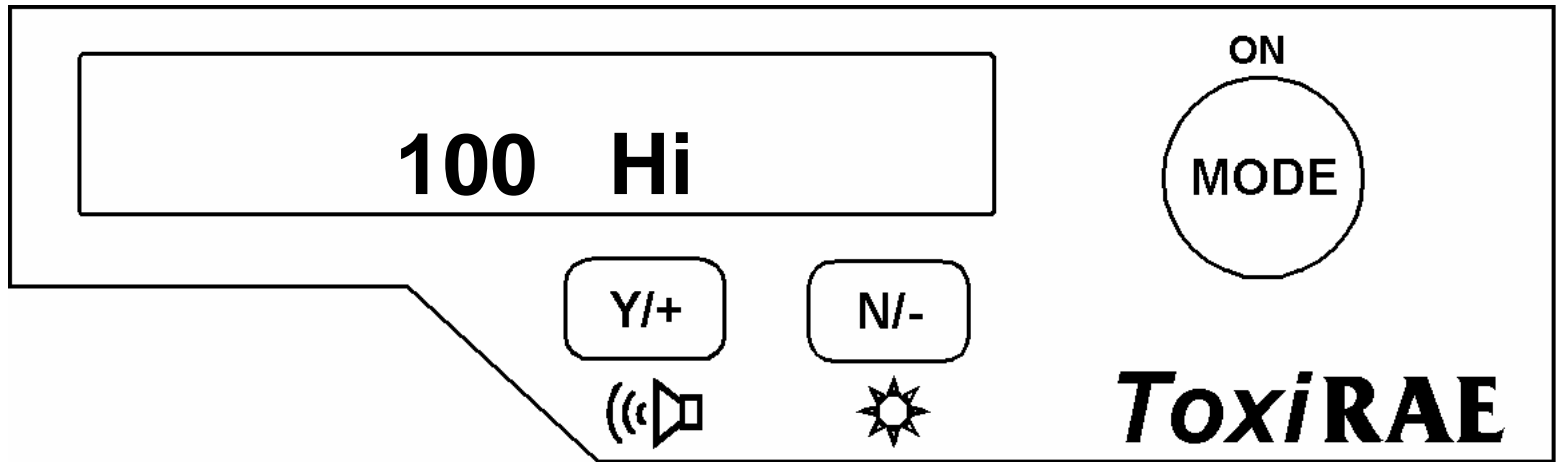

- “Hi” display along with 3 beep audible alarm, flashing alarm LEDs and flashing display backlight indicates that the High alarm setpoint has been exceeded.
- Press “Y/+” key to clear if latching alarm.

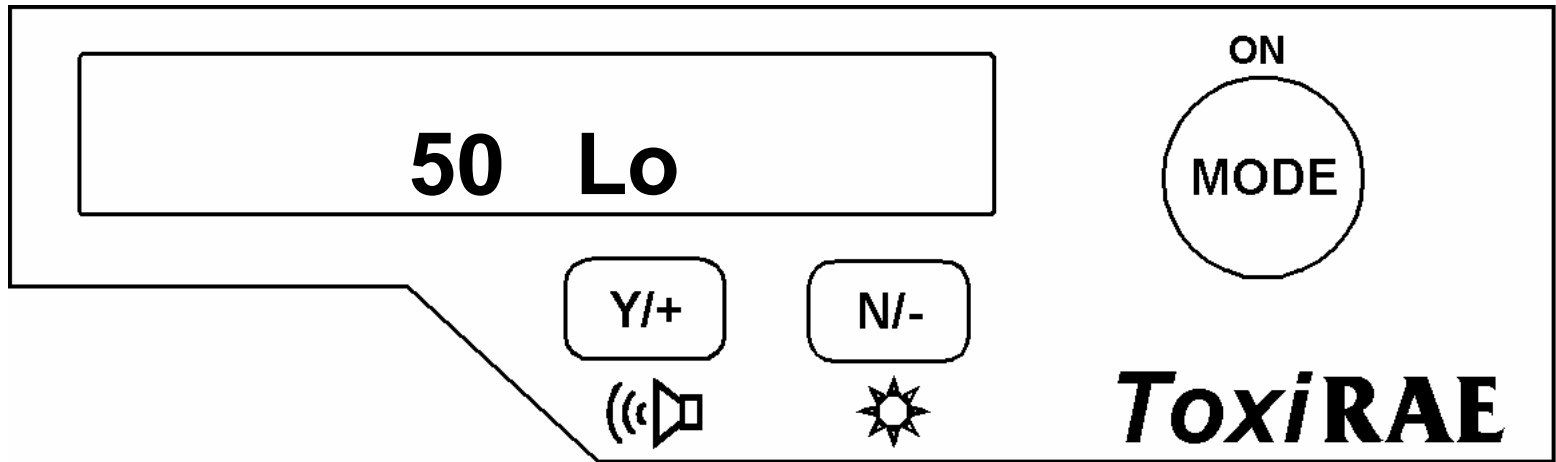

- “Lo” display along with 2 beep audible alarm, flashing alarm LEDs and flashing display backlight indicates that the Low alarm setpoint has been exceeded.
- Press “Y/+” key to clear if latching alarm.

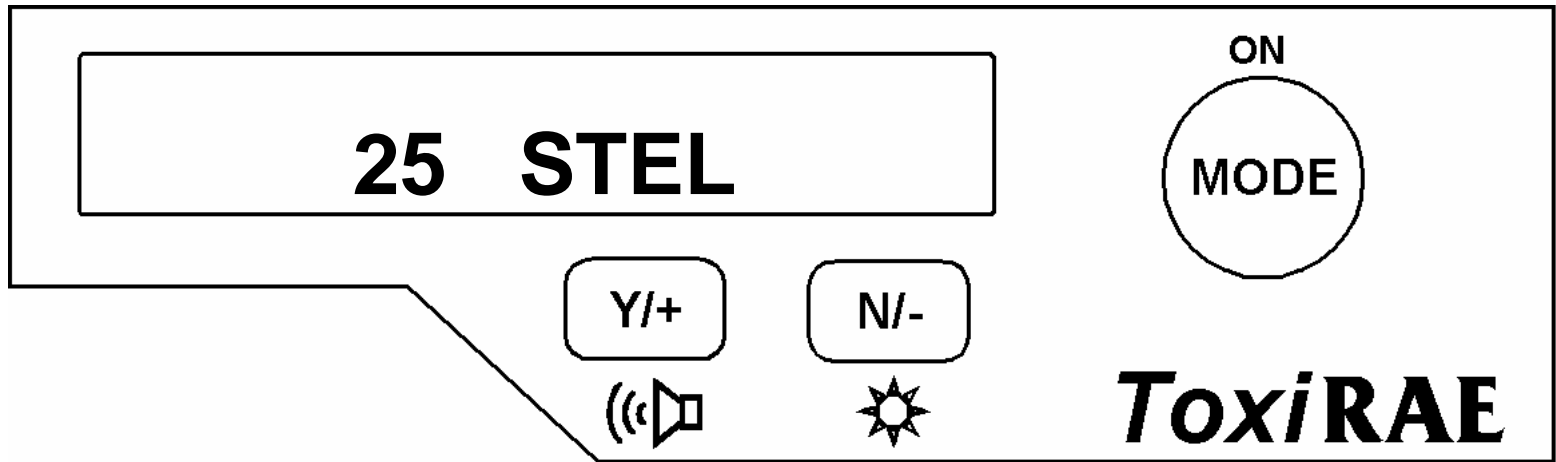

- “STEL” display along with 1 beep per second audible alarm, flashing alarm LEDs and flashing display backlight indicates that the Short Term Exposure alarm setpoint has been exceeded.
- This alarm will only clear if the 15 minute average concentration dips below the STEL alarm setpoint or the PID is turned off.

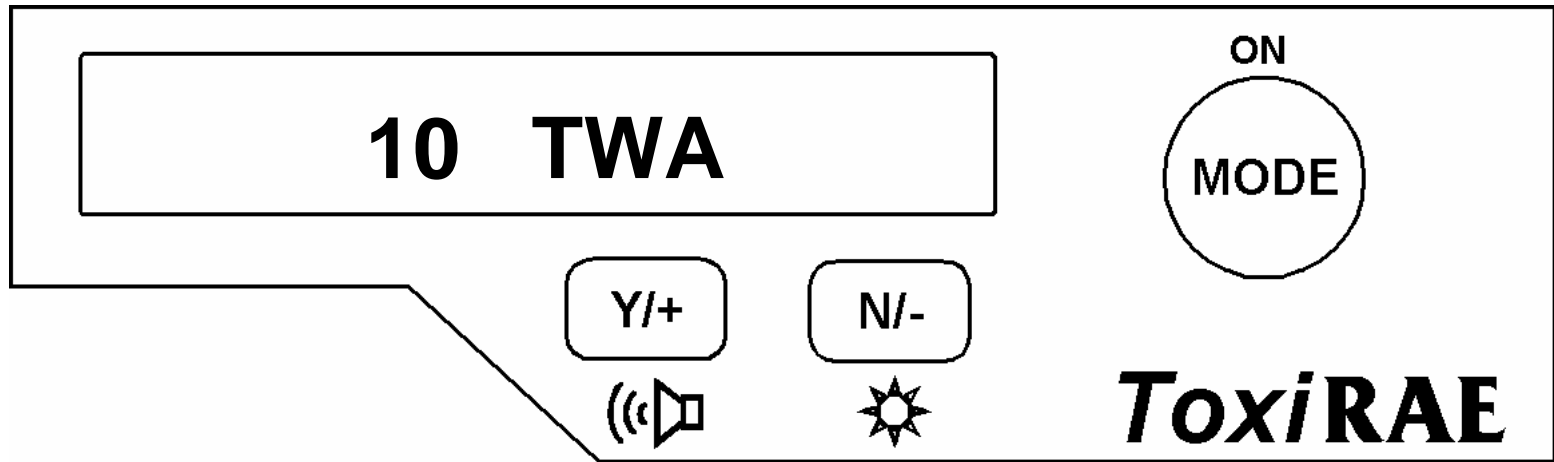

- “TWA” display along with 1 beep per second audible alarm, flashing alarm LEDs and flashing display backlight indicates that the Time Weighted Average alarm setpoint has been exceeded.
- This alarm will only clear if the accumulated reading divided by eight hours dips below the TWA alarm setpoint or the PID is turned off.

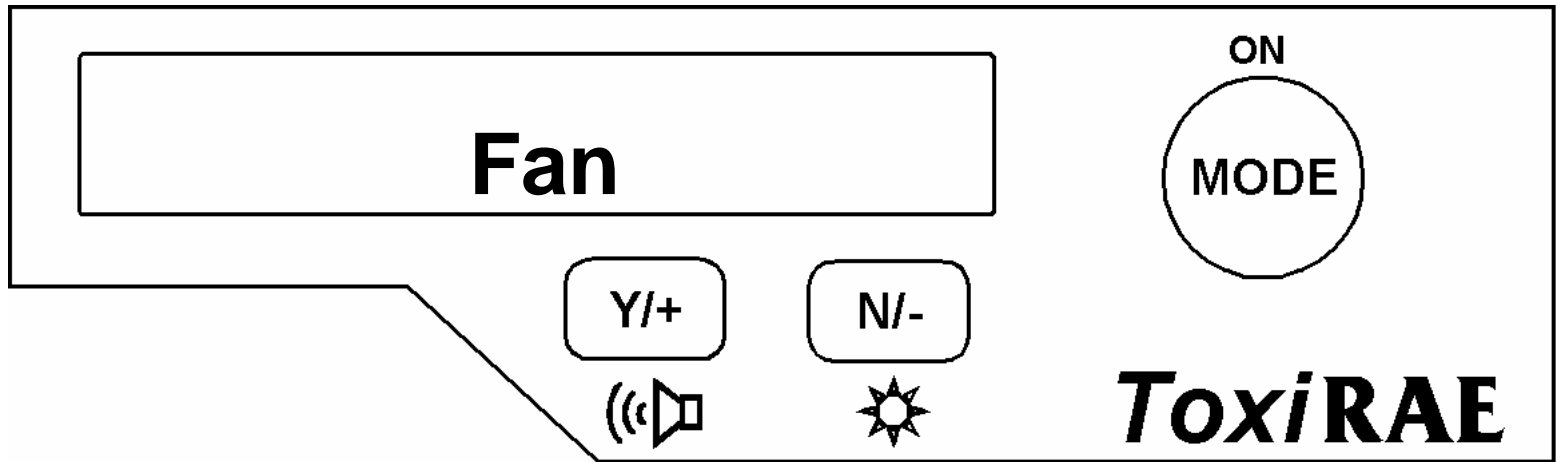

- “Fan” display along with 3 beeps audible alarm indicates that fan has stopped due to either a clog in the fan or an electrical problem.
- Check for blocked fan, but normally this alarm indicated that the fan needs to be replaced

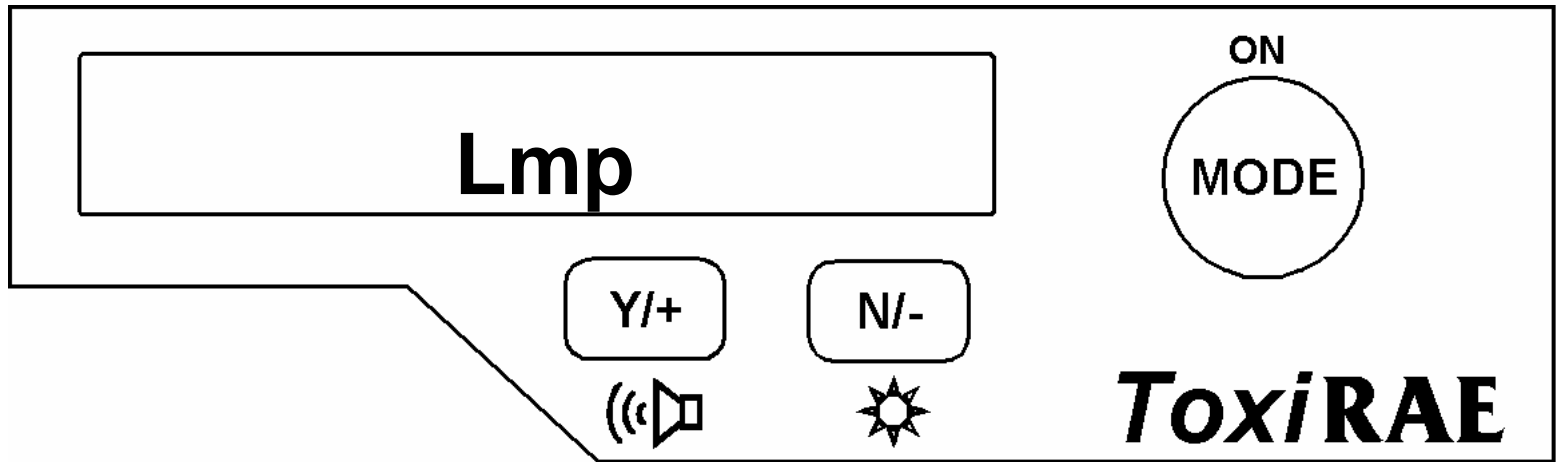

- “Lmp” display along with 3 beeps audible alarm indicates that PID lamp has failed to light
- If after a few minutes the “Lmp” message remains, turn off ToxiRAE Plus PID and restart
 - If after restart “Lmp” message disappears, ToxiRAE Plus PID is ready for use
 - If after restart “Lmp” message remains, the PID needs service

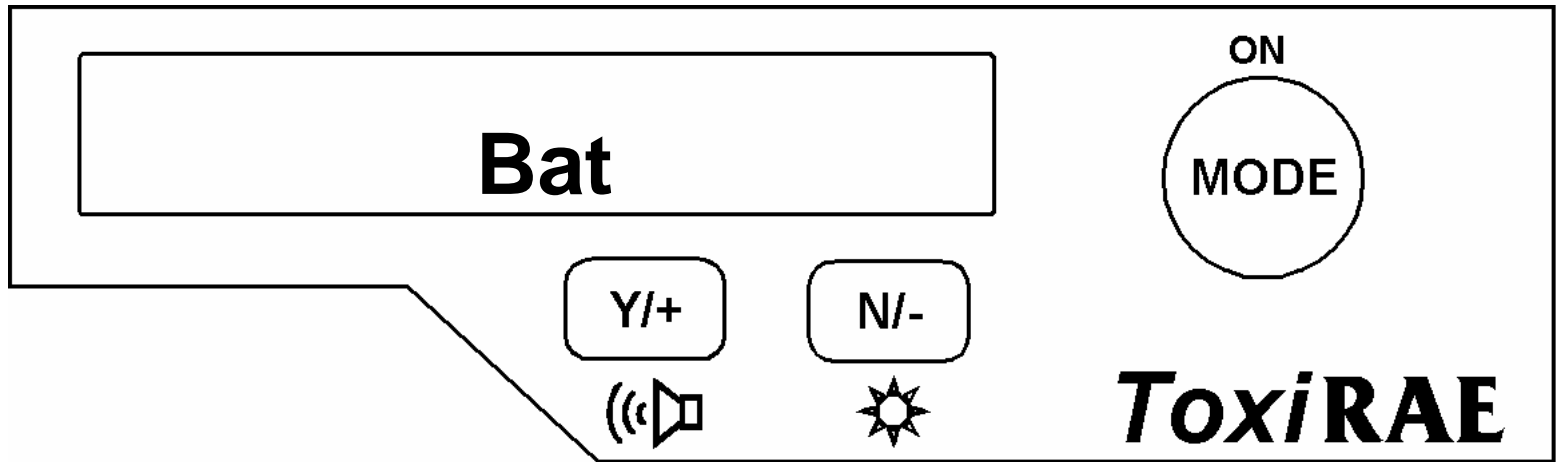

- A flashing "Bat" display along with a 1 beep alarm every 10 seconds indicates that the battery voltage is low and ToxiRAE Plus PID will shut down in 20-30 minutes
- Full battery is over 2.8 volts
- Low Bat alarm is at 2.2 volts
- Shut down is at 2.0 volts

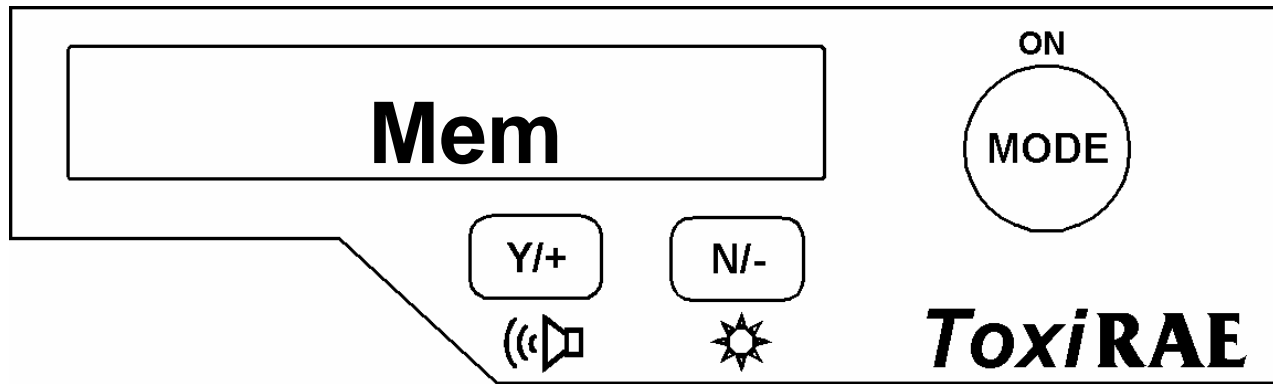

- A flashing “Mem” display along with a 1 beep alarm indicates that the datalogging memory is full
- Select “Clear” to erase the datalogging memory in Programming under the “Data” option to clear the alarm
- 4,000 points downloadable to PC through charging station includes
 - Serial number
 - User ID
 - Site Number

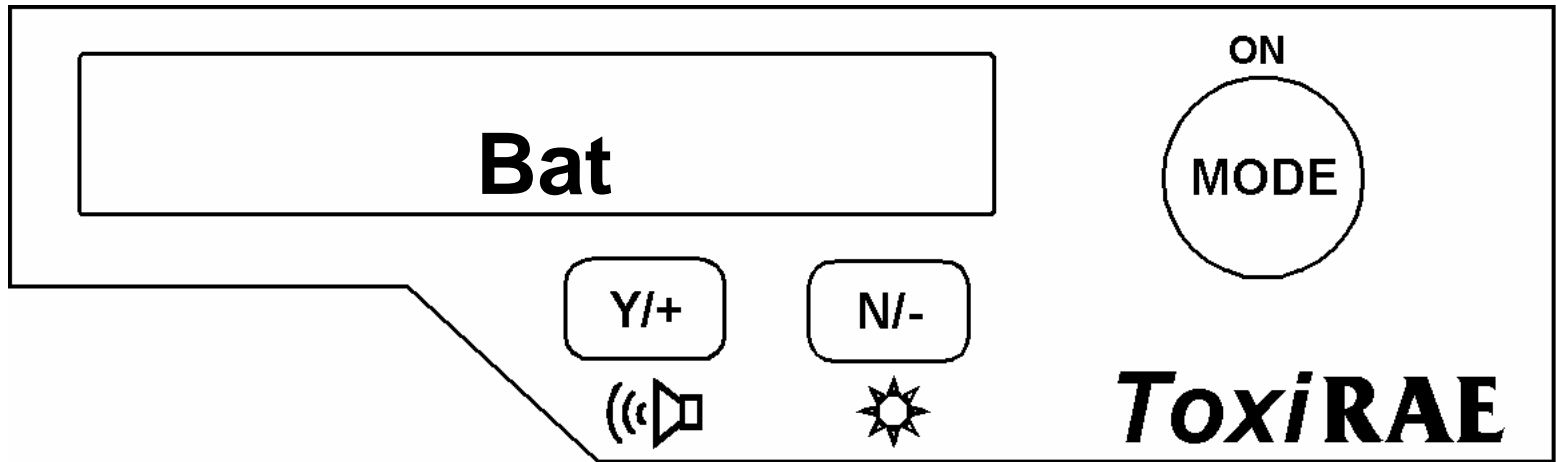

- A flashing "Bat" display along with a 1 beep alarm every 10 seconds indicates that the battery voltage is low and ToxiRAE Plus PID will shut down in 20-30 minutes
- Full battery is over 2.8 volts
- Low Bat alarm is at 2.2 volts
- Shut down is at 2.0 volts



- *Hold “MODE” and “N/-” keys for 5 sec. to enter in to Programming Mode*
- If ToxiRAE Plus PID asks a question “?”
 - Answer “Y/+” or “N/-”
- To Accept or Escape
 - Use “MODE” Key
 - repeatedly pushing the “MODE” key will always eventually return user to main display

- *Use MODE to move between the numbers, Y/+ to change up and N/- to change down, once you have made what changes you want, hold down the MODE until the unit asks “Save?”, press the Y/+ to save or press N/- to discard the changes*



- Code000 *Verify Password
(security level 1)*
- Calib? *Calibrate Instrument*
- Alarm? *Set alarm limits*
- Data? *Set datalogging options*
- Clock? *Set real time clock*
- Gas? *Gas correction factor*
- Setup? *Setup instrument*

Calibrate monitor

- Zero?
 - *Zero gas calibration should be done with a canister of zero grade air, known clean ambient air, or a charcoal filter. The Zero calibration cal can be repeated if a 0.0 reading or something close is not reached*



- Span?
 - *Span gas calibration is the second point of reference.*
 - *Default gas is 100ppm Isobutylene*
- Check?
 - *Span gas check verifies the calibration*
- Cal gas?
 - *Allows you to calibrate to a different value of calibration gas*
- *Press MODE to move to next menu option*



Change alarm limits

- TWA +- 0010.0 *Change TWA alarm*
- STEL +- 0025.0 *Change STEL alarm*
- Lo +- 0050.0 *Change Lo alarm*
- Hi +- 0100.0 *Change Hi alarm*

- *Press MODE to move to next menu option*

Change Datalogging features

- Clear?
 - *Erase the data stored in the non-volatile memory*
- Period?
 - *Set datalogging period. Default value is 60 seconds*
- *Press MODE to move to next menu option*

Change Date and time (*time is a 24-hour clock*)

- Year= +-95 *Change Year*
- Month= +-02 *Change Month*
- Day= +-05 *Change Day*
- Hour= +-14 *Change Hour*
- Minute= +-30 *Change Minute*

- *Press MODE to move to next menu option*

Change gas selection

This allows you to use correction factors to set the instrument to a target gas

- Gas = Isobutylene ?
- *Display shows the previously selected gas, press Y/+ to accept current selection or press N/- to see next available gas pre-stored in unit*
- Factor = +- 001.00
- *Press MODE to move to next menu option*



Change ID data

User and Site ID are stored with each set of datalogging information and can be used to identify different users, jobs or locations

- User 7777
- Site 0001

- *Press MODE to move to next menu option*



- ToxiRAE Plus PID features
- Turning on the ToxiRAE Plus PID
- Recommended Daily Start-up Procedure
- User displays
- Alarm Modes
- Programming displays
- **Calibration**



- ToxiRAE Plus PID uses a two-point calibration process:
 - “zero” gas
 - standard reference gas or “span” gas
- First, “zero” gas which has no detectable organic gases or vapors is used to set the zero point
- Then a standard reference gas (span gas) which contains a known concentration of a given gas is used to set the second point of reference

Supplies needed:

*Regulator, calibration
adapter, span gas, zero
gas*

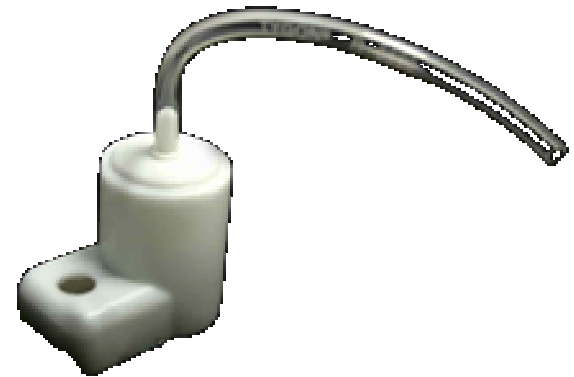



- Enter into Programming Mode by pressing N/- and MODE keys
- The “zero” air is clean dry air without any organic vapor or impurities.
- If such an air bottle is not available, any clean ambient air without detectable contaminants can also be used.
- A charcoal filter should be used if one is not sure of the ambient air’s purity



- Link the calibration adapter on the gas bottle to the sensor cap on the ToxiRAE Plus PID
- “Calib?” is the first menu option in Programming Mode
- Press Y/+ to perform the calibration
- “Zero?” is the first sub-menu to appear on the display
- Turn on the gas flow at the regulator
- Press the Y/+ to start the zero calibration



ToxiRAE Plus PID: Zero calibration

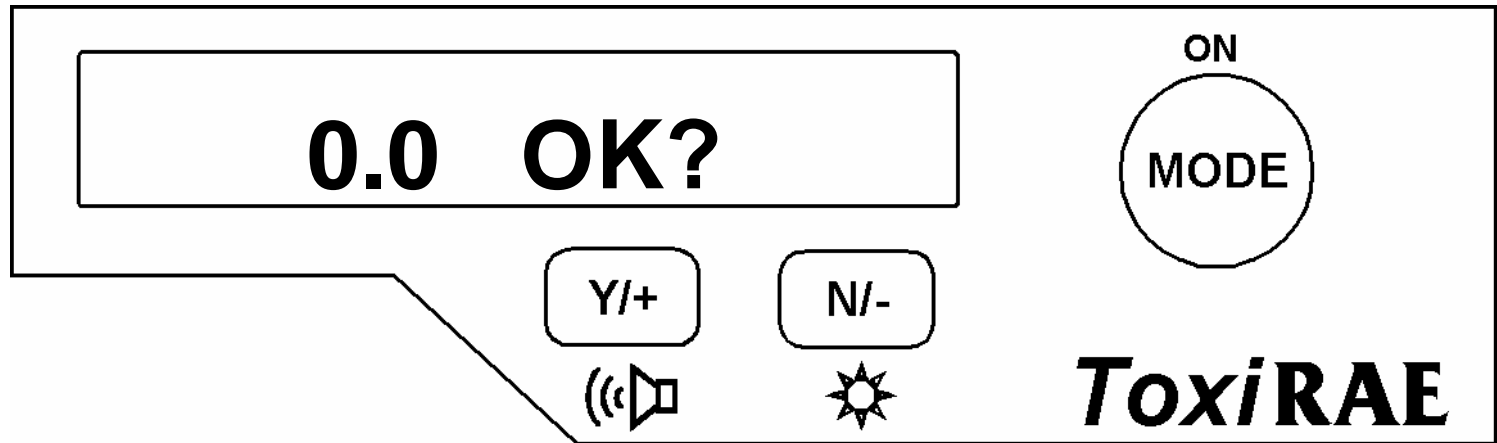

- The ToxiRAE Plus PID will display “zero..” while it runs through its calibration
- This process usually takes about 2 seconds
- When it is finished, the unit should display “0.0 OK?”
- If the value is above zero, press N/- to repeat the zero calibration until a stable 0.0 ppm level is reached



- Press the Y/+ key to exit the zero calibration and move on to the next calibration sub-menu
 - “Span”?

or

- Press the MODE key to exit the calibration sub-menu and move directly to the next menu item in the Programming Mode
 - “Alarm?”

- Display shows “Span?”
- Attach your gas bottle to the regulator
- Attach the regulator to the calibration adapter
- Place adapter on the ToxiRAE Plus PID cap
- Press Y/+ key
- Display will then show “Gas On?”

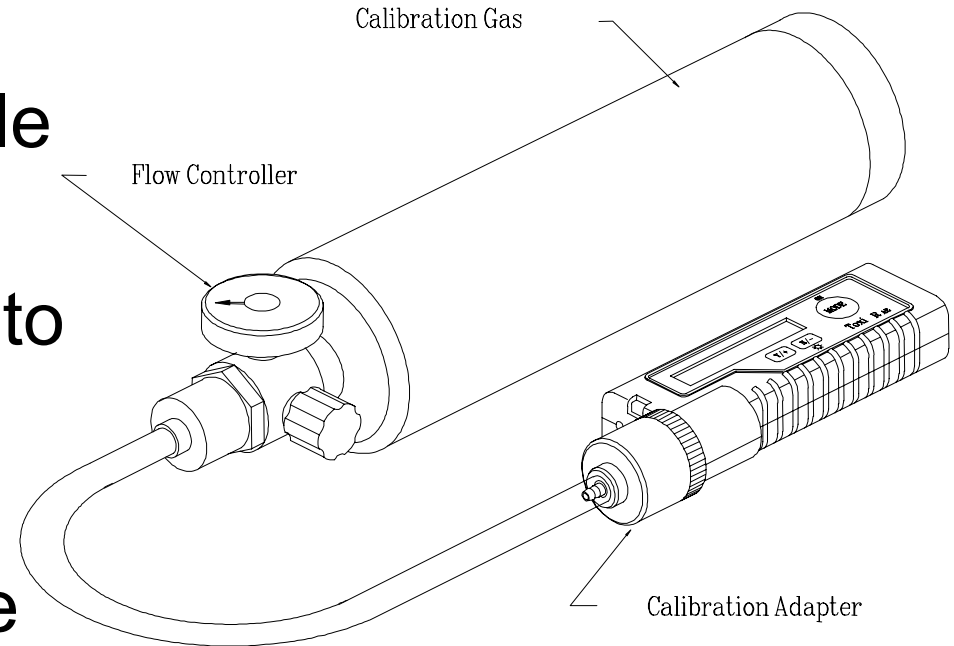

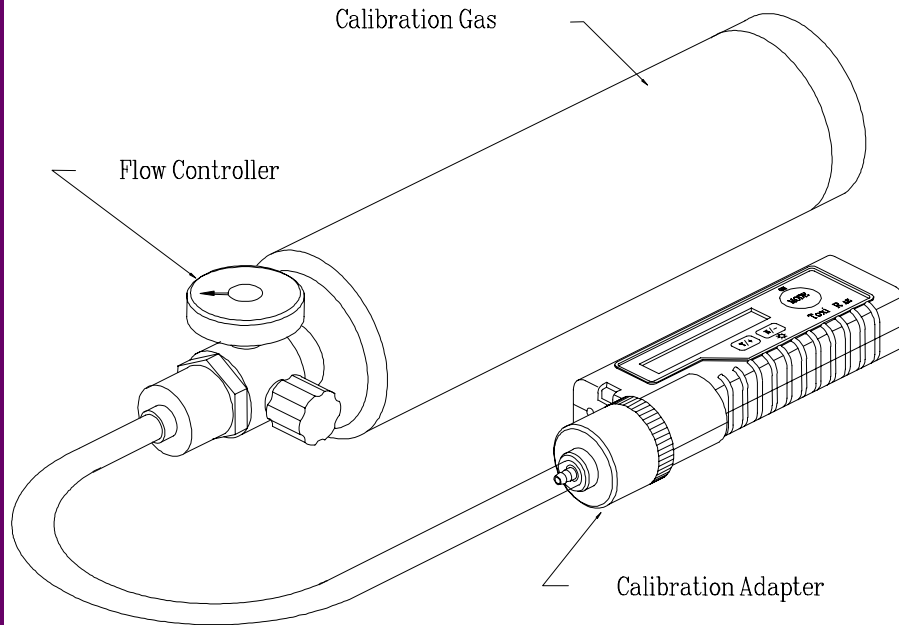

- Turn on valve of gas bottle to start flow of gas
- Apply 100ppm Isobutylene or your span gas
- Display shows “Wait”
- Calibration takes about 30 seconds
- Afterwards, display should show the gas concentration, “100.0 OK?”



- Note: the reading should be very close to the value of the given calibration gas. If the reading is still rising, then the calibration gas has not settled. Wait a few seconds, if it does not match the calibration gas then press N/- to repeat the calibration
- Repeat calibration until reading is within 1 or 2 ppm of the standard gas value



- This completes the span gas calibration
 - Press the Y/+ to exit and proceed to the next sub-menu
 - Turn off gas
 - Remove calibration adapter from ToxiRAE Plus PID
-
- Note: When span calibration is preformed, a time stamp and the actual calibration value is stored in the non-volatile memory. This information will be included in the datalogging report



ToxiRAE Plus PID: Turning off unit

- To turn off the unit
- Press and hold the MODE button for 5 seconds
- Continue to hold as the instrument counts down and beeps once per second
- The message “Off!...” flashes on the LCD and then the screen goes blank
- At this time the unit is completely turned off
- All datalog data is preserved in a non-volatile memory
- however once the unit is turned off all real-time data including TWA, STEL PEAK and Run time is erased
- Place unit in Charging station when not in use



ToxiRAE Plus PID: Smart Charging

- Place unit in charging station, make sure indicator LED turns red
- Ni-Cad Battery is fully charged when LED turns green
- Charging time should be less than 4 hours
- Charging station has trickle charge to protect from over-charging battery
- Battery will develop a memory over time, so you should discharge battery completely if it does not run for 10-12 hours on a full charge





ToxiRAE Plus PID: Alkaline adapter

- ToxiRAE Plus PID also accepts an alkaline adapter with 2 AAA batteries
- Alkaline adapter provides 8-9 hours of operation





Questions?